

MaxMotion

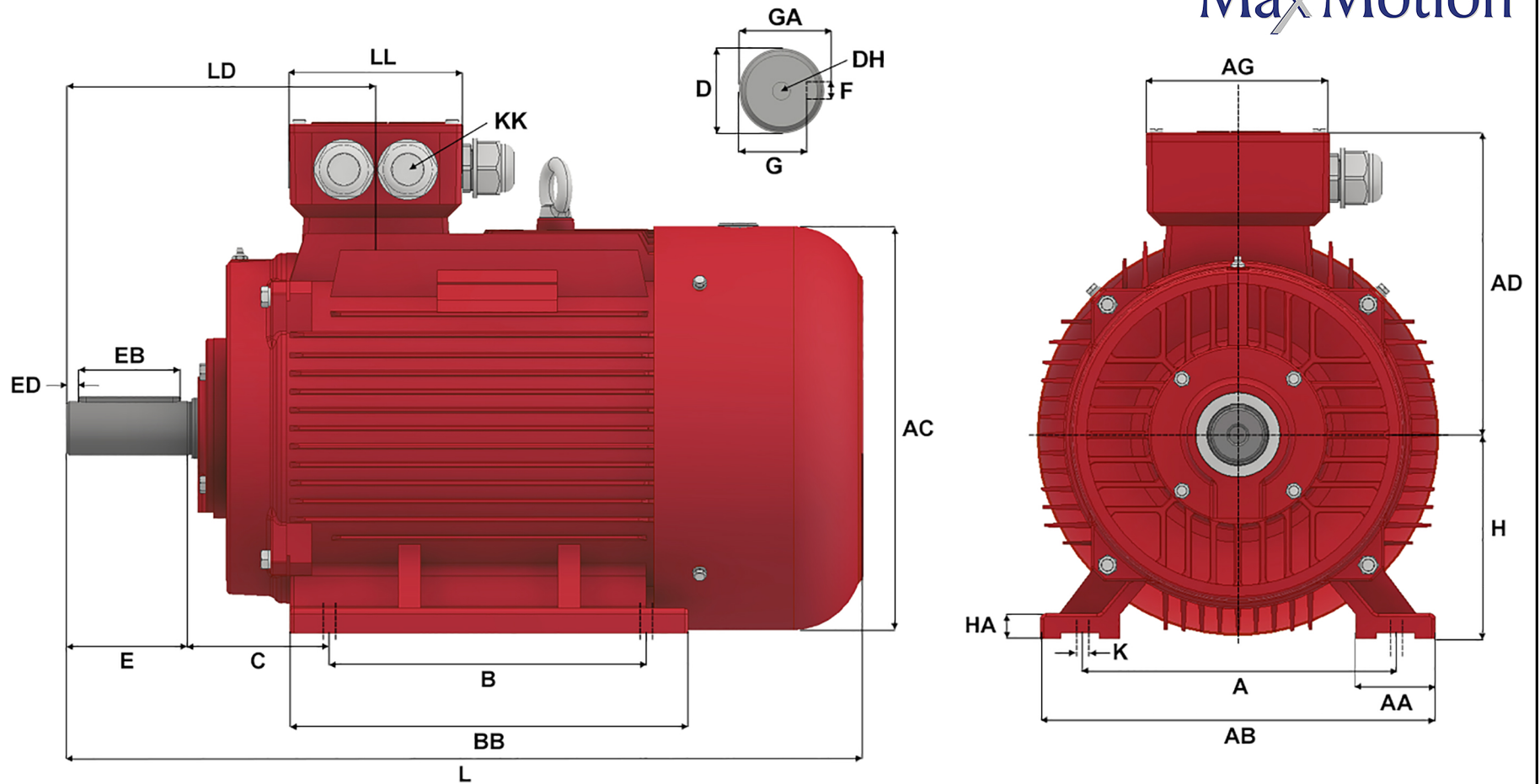

Version: 1JLEM		Revised: 09-11-2019				HP	RPM	FRAME	ENCLOSURE	IJC225M-6-B3			
Customer is responsible in determining that Max Motion product will fit/perform suitably in the intended application						40	1176	225M	TEFC				
A	B	C	D	E	F	G	H	K	L	AA	AB	AC	
356	311	149	60	140	18	53	225	4 - \varnothing 18.5	810	75	431	446	
AD	AG	BA	BB	DH	EB	ED	GA	HA	KK (1)	KK (2)	KK (3)	LD	
326	210	0	393	M20 X 42	125	7.5	64	28	M50 X 1.5	1.5" NPT	M16 X 1.5	329	
LL													
190													